

A



M5 x1

B



M6*30 x1

C



M6*45 x4

D



φ6*φ16 x5

1

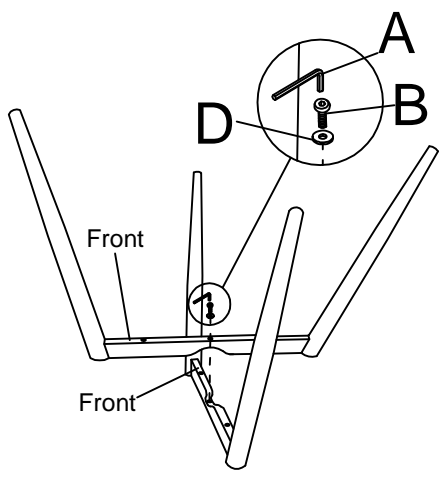

2

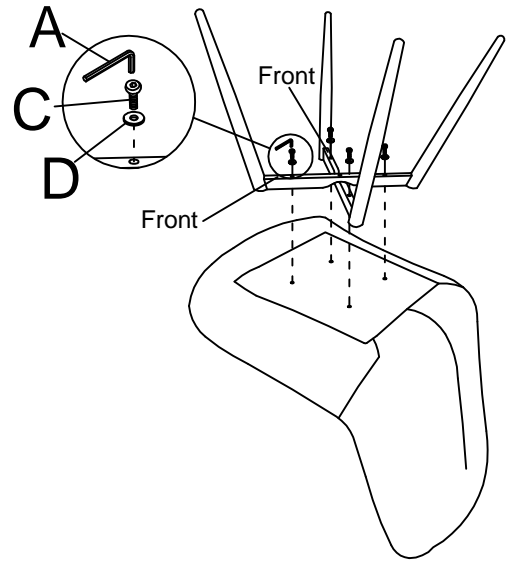

3

