

Przeczytaj uważnie instrukcję przed przystąpieniem do montażu. Upewnij się, że w paczkach znajdują się wszystkie elementy oraz akcesoria montażowe.







Umieść wszystkie drewniane elementy w bezpiecznym miejscu w celu uniknięcia uszkodzeń. Postępuj zgodnie z kolejnymi krokami instrukcji.







Uwaga!

Nie dokręcaj śrub do końca przed ukończeniem montażu.

Nie dokręcaj nakrętek za mocno żeby nie uszkodzić gwintów.

Trzymaj małe elementy poza zasięgiem dzieci.

NO	DESCRIPTION	QTY
1	HEADBOARD 	1 PC
2	FOOTBOARD 	1 PC
3	SIDE RAIL 	2 PCS
4	LVL SLATS 	16 PCS
5	VERTICAL RAIL 	1 PC
6	SIDE PLASTIC CAP 	32 PCS
7	BED LEG 	4 PCS

NO	DESCRIPTION	QTY
A	JCBB M8 X 40MM 	8PCS
B	JCBC M6 X 50MM 	2PCS
C	SPRING WASHER 5/16" 	10PCS
D	FLAT WASHER 5/16" 	8PCS
E	FLAT WASHER 1/4" 	2PCS
F	ALLEN KEY M4 	1PC
G	ALLEN KEY M5 	1PC

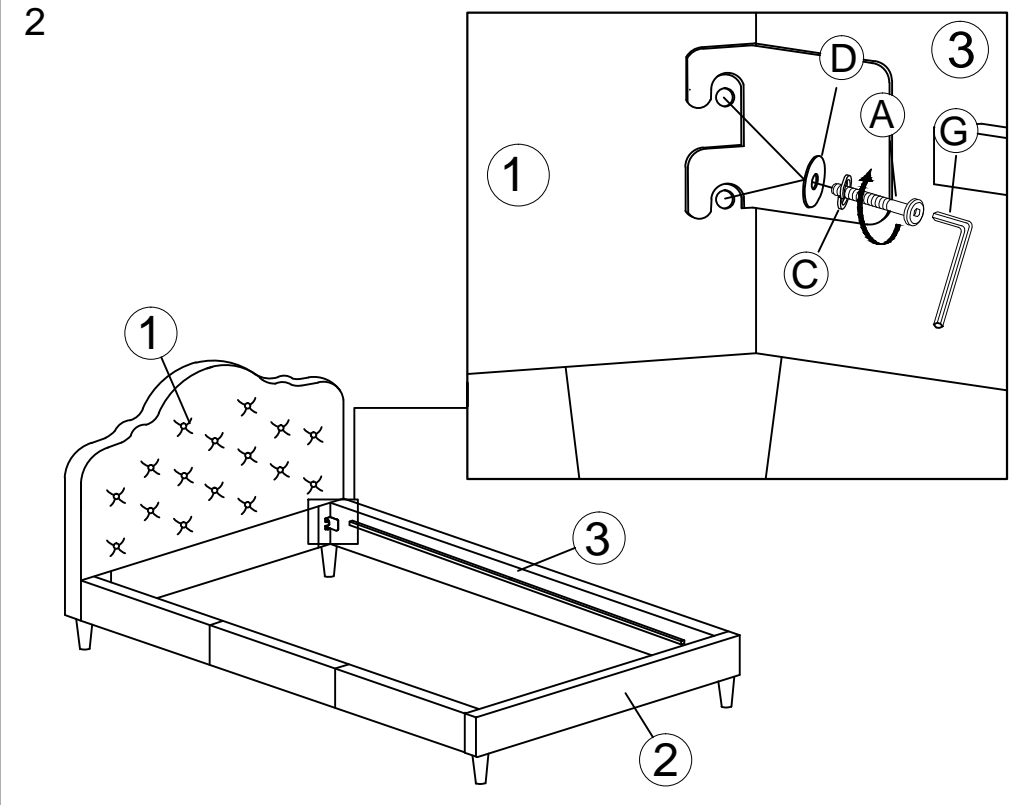
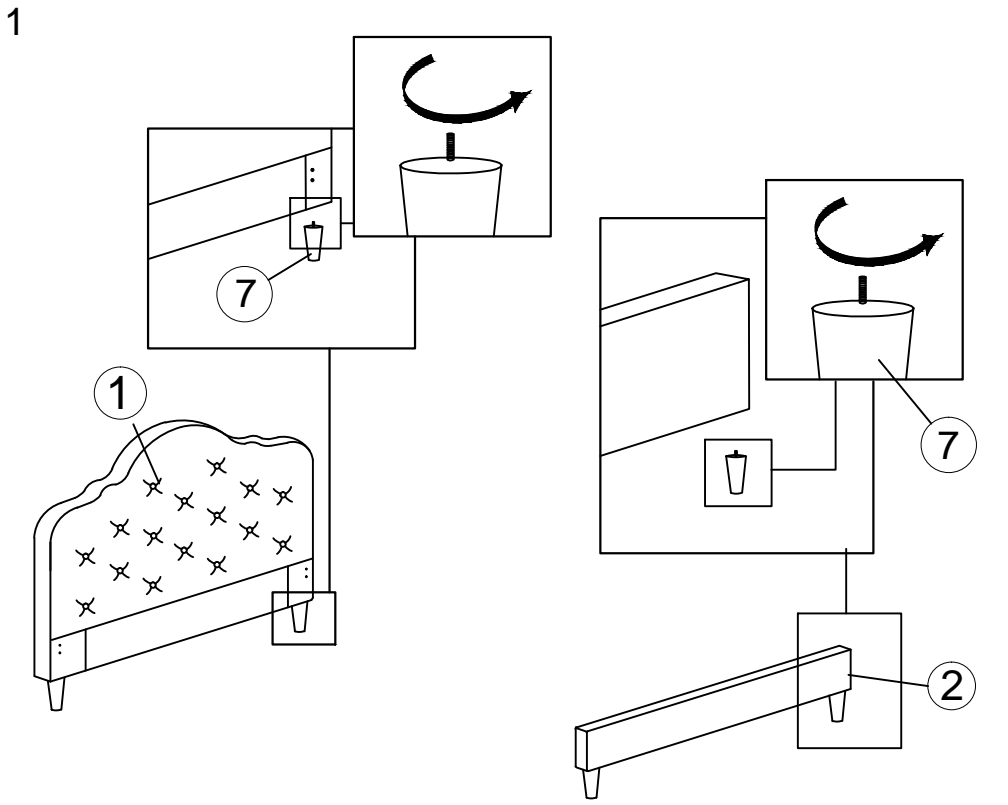

3

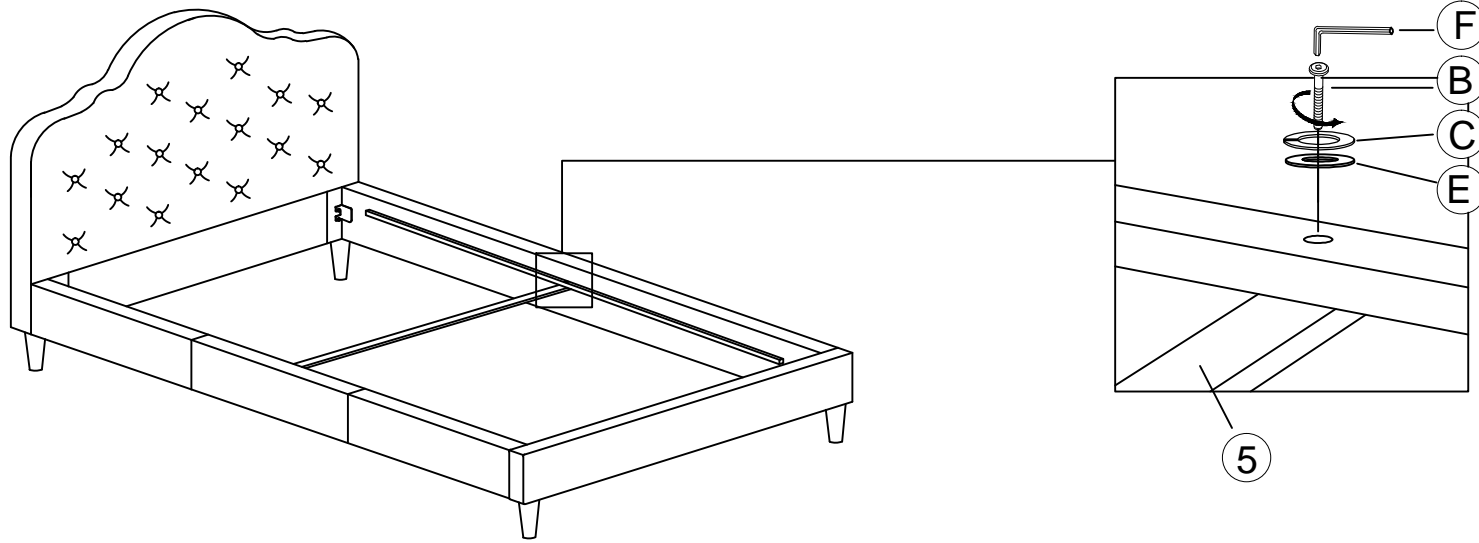

4

