

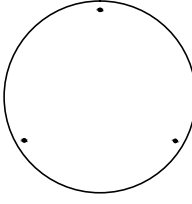

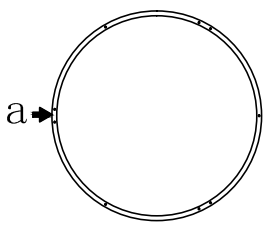
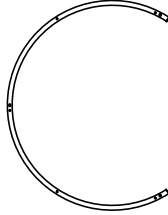
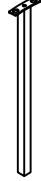
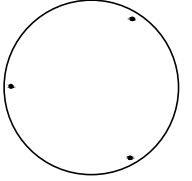
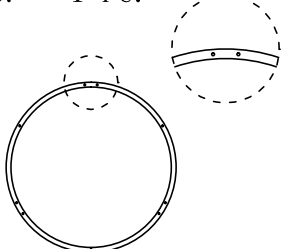
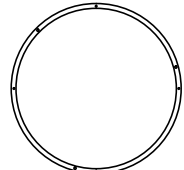
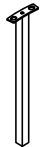

MODEL ATLANTA II

PARTS LIST

<p>1. - 1 Pc.</p> 	<p>2. - 1 Pc.</p> 	<p>3. - 1 Pc.</p> 	<p>4. - 3 Pcs.</p> 
<p>5. - 1 Pc.</p> 	<p>6. - 1 Pc.</p> 	<p>7. - 1 Pc.</p> 	<p>8. - 3 Pcs.</p> 

FITTINGS

<p>A. -6Pcs</p> 	<p>B. M6-6Pcs</p> 	<p>C. M6-12Pcs</p> 	<p>D. -1Pc</p> 
---	---	---	--

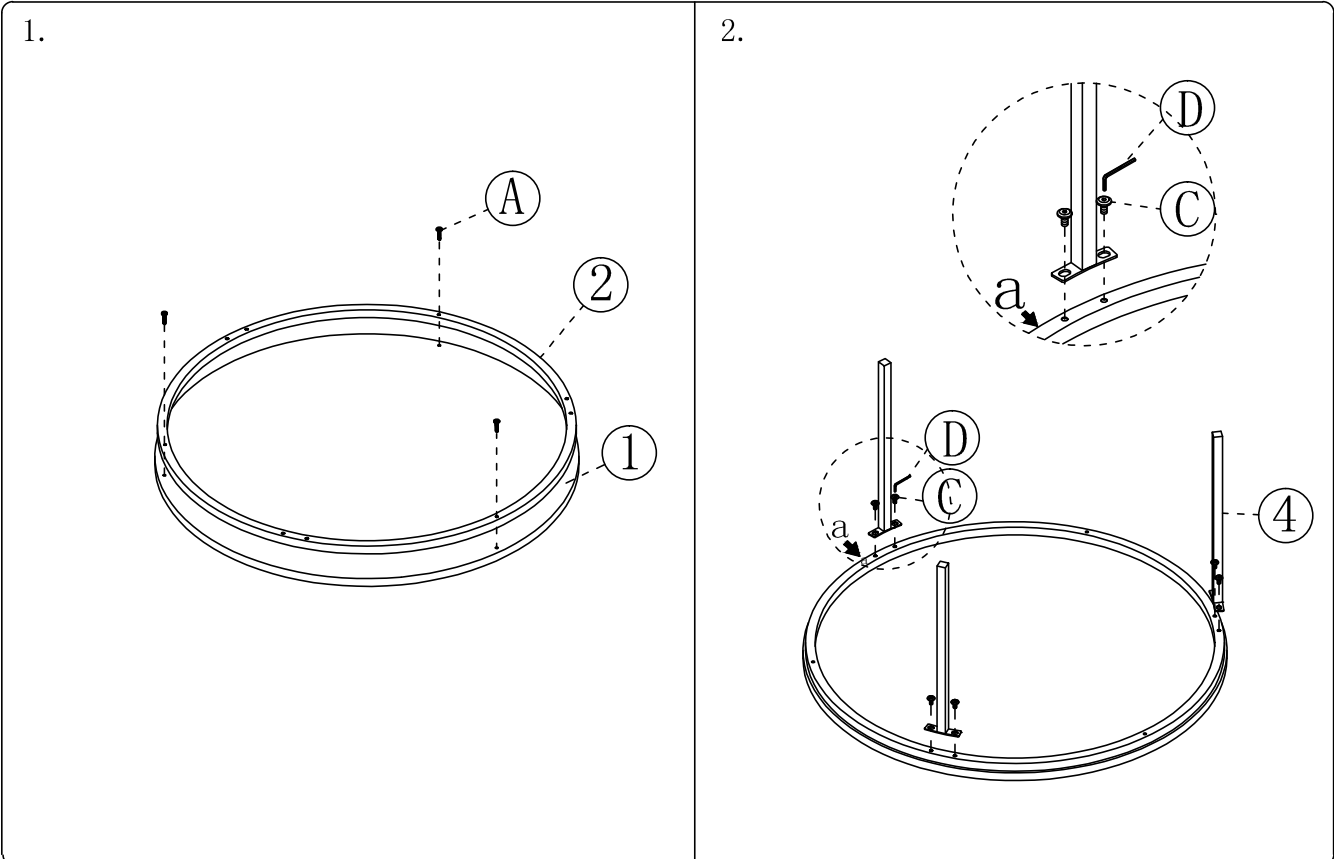

3.

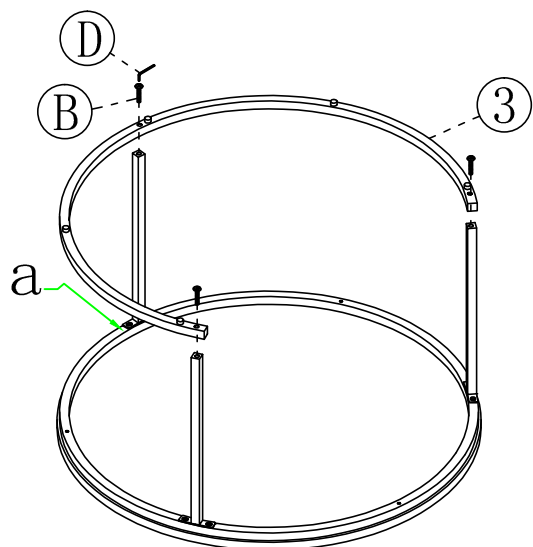

4.

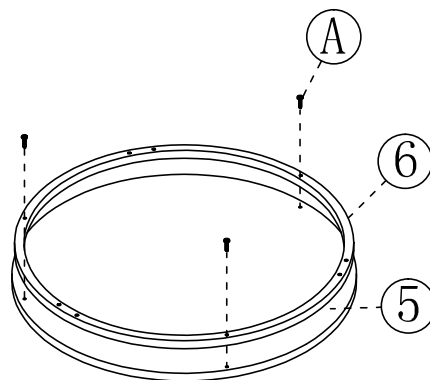

5.

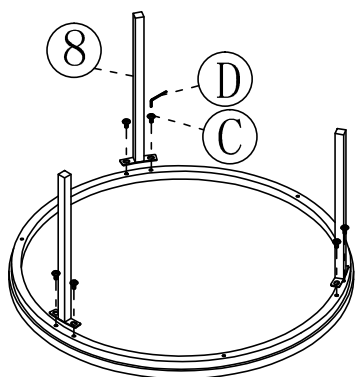

6.

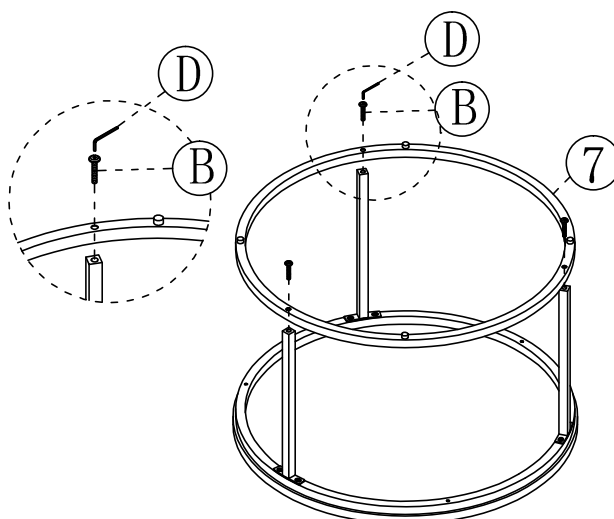

7.

